

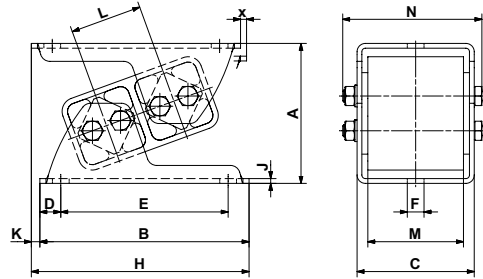

Anti-vibration Mounts

Type ESL

up to ESL 45



as from ESL 50

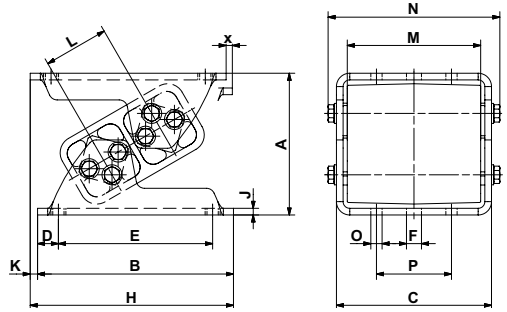

Art. No.	Type	Load Gmin. – Gmax. [N] on Z-axis	A un- loaded	A* max. load	B	C	D	E	øF	H	J	K	L	M	N	Weight [kg]
05 021 001	ESL 15	200 – 550	54	43	85	49	10	65	7	91	2	5.5	25.5	40	58.5	0.4
05 021 002	ESL 18	450 – 1'250	65	51	105	60	12.5	80	9.5	111	2.5	5.5	31	50	69	0.6
05 021 003	ESL 27	700 – 2'000	88	68	140	71	15	110	11.5	148	3	8	44	60	85.3	1.3
05 021 004	ESL 38	1'300 – 3'800	117	91	175	98	17.5	140	14	182	4	7	60	80	117	3.4
05 021 005	ESL 45	2'200 – 6'000	143	110	220	120	25	170	18	235	5	15	73	100	138	5.3
05 021 016	ESL 50	4'000 – 11'000	170	138	235	142	25	185	18	244	6	9	78	120	162	10.8
05 021 017	ESL 50-1.6	5'500 – 15'000	170	138	235	186	25	185	18	244	8	9	78	160	206	15.4
05 021 018	ESL 50-2	7'000 – 19'000	170	138	235	226	25	185	18	244	8	9	78	200	246	17.8

Art. No.	Type	Natural frequency Gmin. – Gmax. [Hz]	O	P	x max.	Material structure (zinc-plated screws)
05 021 001	ESL 15	8.2 – 5.8	-	-	1.5	Light metal profiles, steel brackets, ROSTA blue painted
05 021 002	ESL 18	7.5 – 5.0	-	-	1.9	
05 021 003	ESL 27	6.2 – 4.5	-	-	2.7	
05 021 004	ESL 38	5.5 – 4.0	-	-	3.6	
05 021 005	ESL 45	5.0 – 3.5	-	-	4.4	
05 021 016	ESL 50	5.0 – 3.5	13.5	90	10	Light metal profiles, cast housings, steel brackets, ROSTA blue painted
05 021 017	ESL 50-1.6	5.0 – 3.5	13.5	90	10	
05 021 018	ESL 50-2	5.0 – 3.5	13.5	90	10	

The max. load on **X-axis** should not exceed **200%** of the Z-axis capacity.

The max. load on **Y-axis** should not exceed **20%** of the Z-axis capacity.

Applicable on tensile, pressure and shear load.

These types can be combined with one another (identical heights and operation behaviour)

* compression load Gmax. and final cold flow compensation (after approx. 1 year).

Guidelines concerning customized mounts and examples as from page 3.14.



Anti-vibration Mounts

Type ESL

Deflection curves and cold flow behaviour

The below mentioned deflection values are comprising the initial cold flow, occurring after a few hours of operation. The final cold flow (after one year) is usually $s \times 1.09$. The mentioned deflection values are not suitable for type testing. Please consult also our tolerance data in the general catalogue, chapter "Technology".

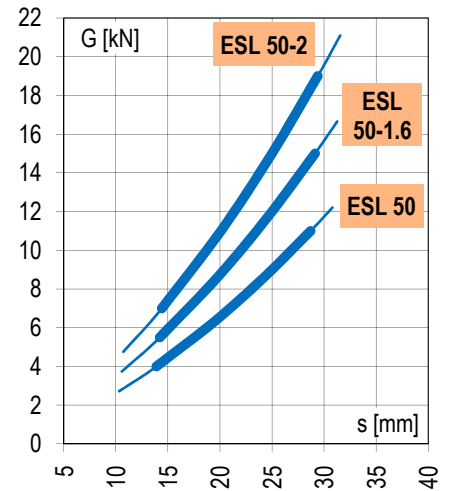
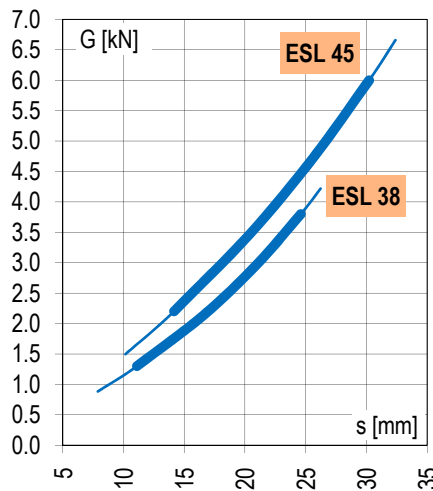
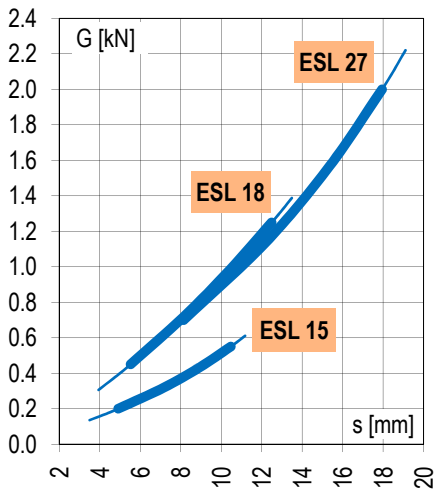
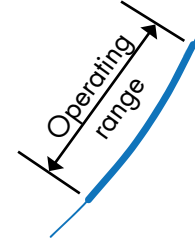

Installation guidelines

The ESL elements must generally be installed in the same direction.

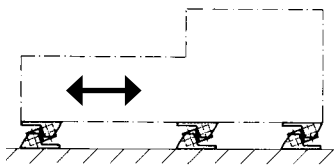

Dynamic forces longitudinal

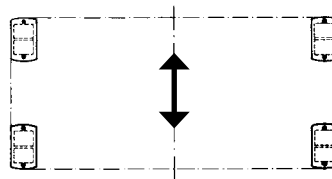

Dynamic forces lateral

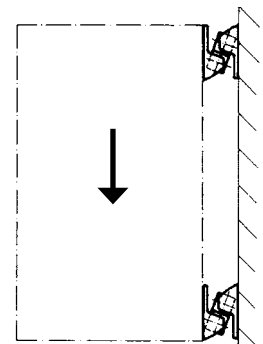





Wall mounting
(Mounting direction should be complied)

Applications

For active and passive isolation of vibrations and maximum damping of solid-borne noise transmission in weighbridges and scales, measuring systems, control equipment, rotary machinery such as compressors, refrigerating systems, blowers, pumps, mills, mixers, shock-absorbent buffers, etc.

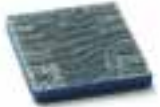
Selection table for Anti-vibration Mounts

Type	Description	Details	Illustration
ESL	<p>Anti-vibration Mounts for the absorption of tensile, pressure and shear load. Also ideal for wall and ceiling installations.</p> <p>8 load sizes from 200 N to 19'000 N per mount.</p> <p>Natural frequency between 3,5 – 8 Hz. Mounts are mainly used for overcritical machine installations (machine frequency > mount frequency).</p>	Page 3.8 – 3.9	
V	<p>Anti-vibration Mounts for the absorption of tensile, pressure and shear load. Also ideal for wall and ceiling installations.</p> <p>6 load sizes from 300 N to 12'000 N per mount.</p> <p>Natural frequency between 10 – 30 Hz. Mounts can be used for subcritical machine installations (machine frequency < mount frequency).</p>	Page 3.10 – 3.11	
N	<p>Mounting Feets consisting of insulating plate, glued-on top cover with built-in levelling jackscrew with spherical joint for compensation of up to 5° of floor unevenness. Insulating plate oil- and acid-proof.</p> <p>3 load sizes from 1'500 N to 20'000 N per mount.</p> <p>Natural frequency between 19 – 25 Hz.</p>	Page 3.12	
NOX	<p>Mounting Feets consisting of insulating plate, stainless steel glued-on top cover with built-in stainless levelling jackscrew with spherical joint for compensation of up to 5° of floor unevenness. Insulating plate oil- and acid-proof.</p> <p>2 load sizes from 5'000 N to 20'000 N per mount.</p> <p>Natural frequency between 19 – 22 Hz.</p>	Page 3.12	
Base plate P	<p>Accessories: For all N and NOX mounting feet light metal cast base plates are available for the compensation of possible shear loads and/or for the positioning of the installation on the floor.</p>	Page 3.12	
ISCOL	<p>Adhesive cushioning plates, self-adhesive plates for the installation of smaller machines/equipments. Plates oil- and acid-proof. (Adhesive power can be increased by moistening the plate with nitro thinner.)</p>	Page 3.13	
ISCOL U	<p>Adhesive cushioning plates, self-adhesive plates with glued-on cast cover. With central hollow in cover for the positioning of the levelling jackscrew – also with lateral stop bar for machine positioning.</p>	Page 3.13	

Further information to customized elements and installation examples as from page 3.14.